

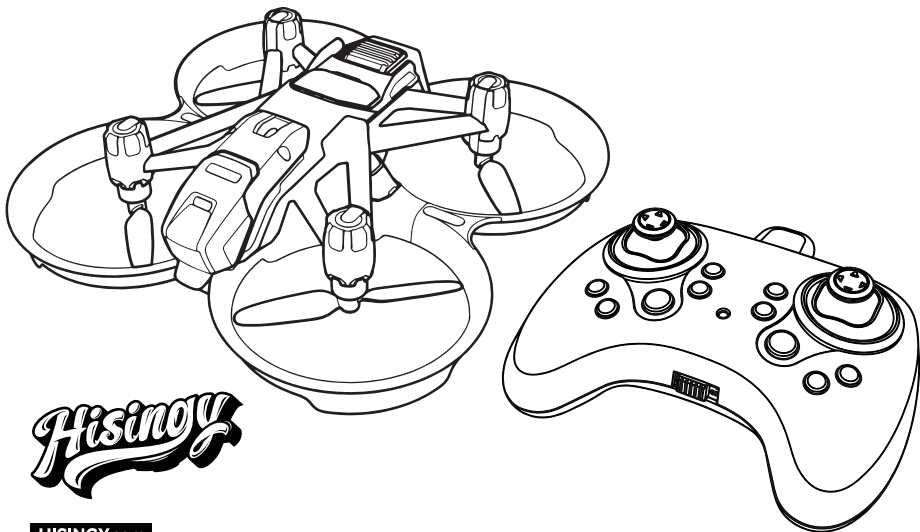

FIREFLY-EX

JOURNEY STARTS HERE

FLY ANYWHERE AT ANYTIME, FEEL THE THRILL
OF THE IMMERSIVE INDOOR FPV EXPERIENCE



Hisingy

[HISINGY.com](https://www.hisingy.com)

**DESIGNED BY PROS
FOR EVERYONE**

INSTRUCTION MANUAL

FPV MADE EASY
GO EASY COPTER



FIREFLY-EX



**Please read this instruction manual carefully before using this product.
This instruction manual contains important information, please
safekeeping.**



CATALOGUE

FIREFLY-EX INTRODUCTION	11
------------------------------------	----



INTRODUCTION EC-15	12
---------------------------	----



OPERATION GUIDE	
▸ Binding	
▸ Flight Control	
▸ Start flying	
▸ Hover (Important)	
▸ Land	14



OTHER FUNCTIONS	
▸ Aircraft trim	
▸ Emergency stop	
▸ Speed adjustment	
▸ Headless	
▸ LED lights	
▸ Flip	
▸ Cicle Fly	21



DECAL	26
--------------	----



HISINGY APP	
▸ Download HISINGY App	
▸ App Item	28



DISCLAIMER	30
-------------------	----



AFTER-SALES SERVICE REGULATIONS	35
--	----





NOTICE

All instructions, warranties and other related documents are subjected to change at the sole discretion of “HISINGY” Cockatoo & Friends Co., Ltd. For up-to-date information and other supports please visit official website www.hisingy.com.



Terminology of Importance

The following terms are used throughout the product literature to indicate various levels of potential harm when operating this product.



WARNING

Failure to follow the procedures described in the following section properly create the probability of property damage, collateral damage, and serious injury or create a high probability of superficial injury.



CAUTION

Failure to follow the procedures described in the following section properly create the probability of physical property damage and a possibility of serious injury.



NOTICE

Failure to follow the procedures described in this instruction may result in property damage but there is little chance of injury.



WARNING

- Please read the ENTIRE instruction manual to familiarize with the product features before using. Failure to operate the product correctly can result in product damage, property damage and cause serious injury.
- This is a sophisticated product. Please exercise cautions when operating. Common sense and basic mechanical ability are required.
- Failure to use this product in a safe and responsible manner may result in damage to the product or other property.
- This product is not intended for use by children without adult supervision. Do not use incompatible components or alter this product in any way outside of the instructions provided by "HISINGY" Cockatoo & Friends Co., Ltd. This document contains detailed instructions for safety, operation and maintenance. It is essential to read and follow all the instructions and warnings in advance so as to proper operation and to avoid product damage or serious injury.





Safety Precautions and Warnings

1. Always keep a safe distance in all directions around your aircraft to avoid collision or damage. This aircraft is controlled by radio signals may be subject to interference from many sources (Wi-Fi routers, cell towers, microwave, large home appliances, radio stations, etc.) that is out of your control. These interference can cause momentary control loss to the aircraft.
2. Always operate your aircraft in an indoor space away from vehicles, roads, traffic and people.
3. Always carefully follow the directions and warnings on this product and optional supporting equipment (chargers, rechargeable flight / device battery, etc.).
4. Always keep all chemicals, small parts and anything electrical (flight / device battery) out of the reach of children.
5. Always keep all non-waterproof equipment out of contact with water, moisture can damage electronic equipment.
6. The operating temperature range of the aircraft, controller, FPV headset and charger is 0°C-45°C. Operating at temperatures below or exceeding the specified temperature range could affect the flight battery and device battery, resulting in loss of performance, compromise of structural integrity and safety problems, and could cause overheating or leaking. Do not operate when the temperature exceeds 45°C.
7. Never place any portion of the aircraft in your mouth, as it could cause serious injury or even death.
8. Never operate your aircraft with low controller / FPV headset battery.
9. Always keep your aircraft in sight and under control.
10. Always move the throttle fully down or trigger the emergency cutoff function at the time of the crash.
11. Do not stare at the LED indicator light at the rear of the aircraft closely for a long period of time, as this may result in eye discomfort.
12. Always use fully charged batteries.
13. Always keep controller powered on while the aircraft is powered on.
14. Always remove batteries before disassembly and assembly.
15. Always keep moving parts (motors and propellers) clean.
16. Always remove batteries after use.
17. Never operate aircraft with damaged wiring.
18. Never touch moving parts (motors and propellers).



WARNING: Do not touch rotating propeller blades. Always keep a safe distance from rotating propellers to avoid incision.

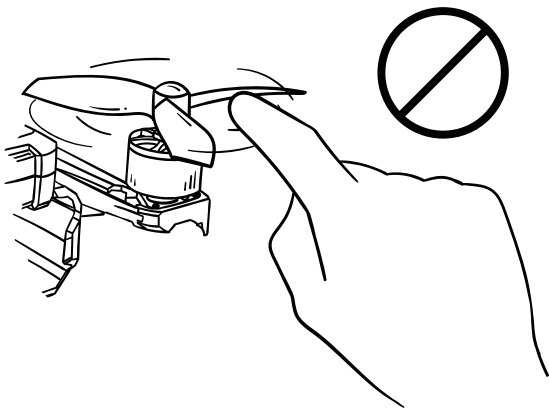



WARNING: Do not fly over crowded or over people.

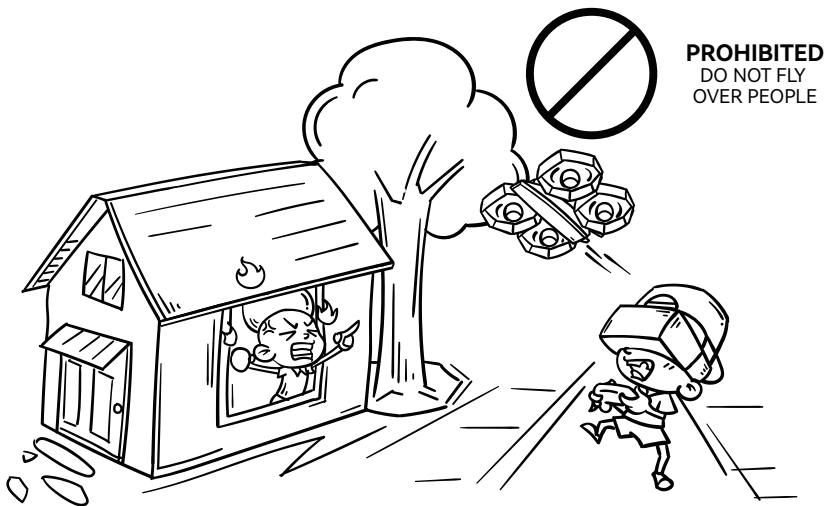



WARNING: Please follow local privacy laws and regulations when operating the aircraft. To avoid interrupting aviation radio signals and air traffic, operating your aircraft within 5 statute miles of an airport is strictly prohibited. The use of remote controllers and the aircraft should be stopped as required, during the period and/or within the area where radio restrictions were imposed by the government.



**PROHIBITED
FLY LEGALLY**



AIRPORT

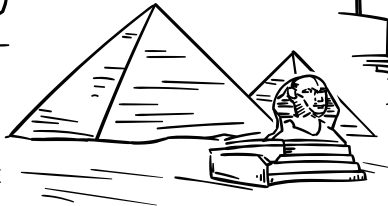

HISTORICAL ARCHITECTURE



MILITARY BASE

LET'S GO



JOURNEY STARTS HERE

FIREFLY-EX INTRODUCTION

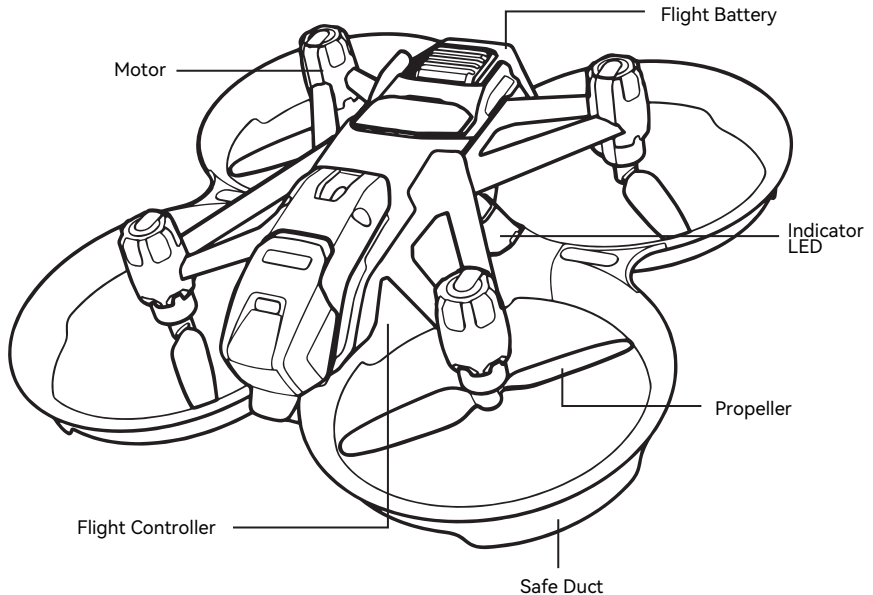

INTRODUCTION EC-15

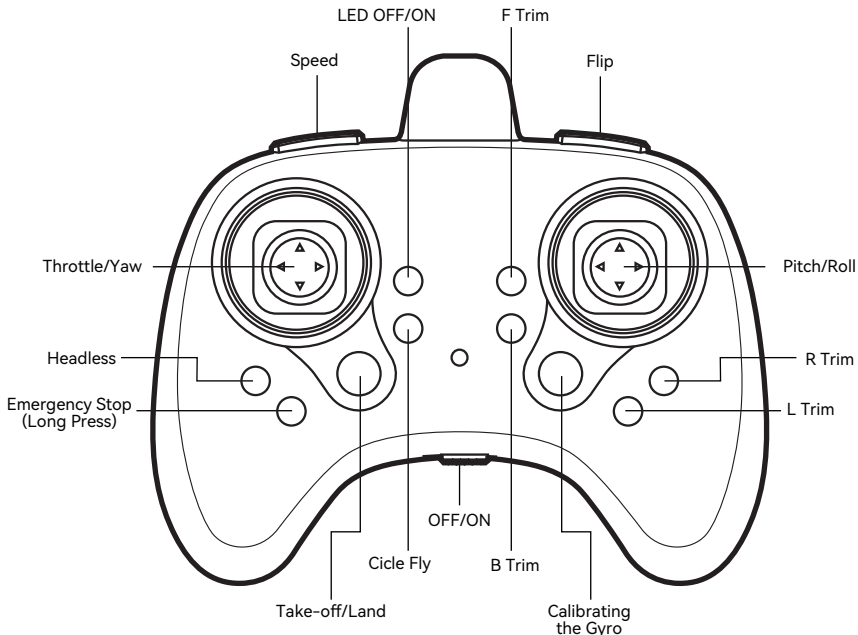

FLIGHT BATTERIES AND EQUIPMENT BATTERIES

Low battery alarm

When the battery level of the controller is lower than 10%, low battery alarm will be activated.

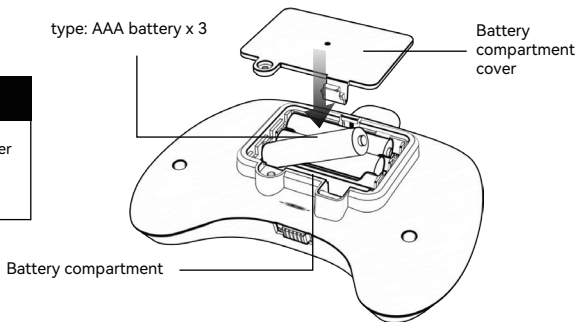

The flight battery is equipped with a USB charging cable

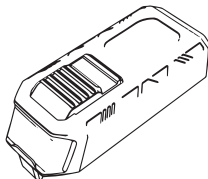

Flight battery*1



Charging line*1

OPERATION GUIDE

BINDING

1. Turn on the remote control power.

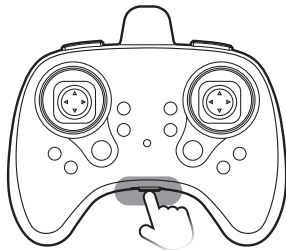

Turn on the switch

2. Connect the battery to the drone to power it up, and place the drone on a flat surface. (The nose should face forward, and the tail should be at the back.) The LED light will blink.

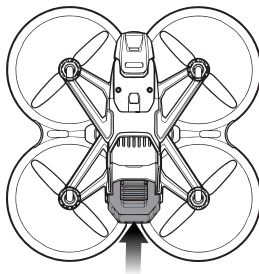

Insert the battery into the aircraft.

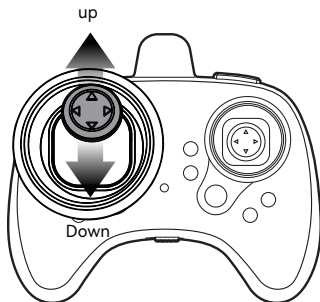

3. Push the left joystick on the remote control all the way up and then all the way down to pair the remote control with the drone. After pairing, the remote control indicator light will stay on, and the drone's LED light will stay on.

The drone's front is facing forward

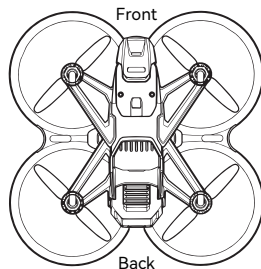

4. After pairing with the drone, briefly press the gyroscope calibration button on the remote control. The remote control will emit a beep, and the drone's LED light will flash quickly for 2 seconds. At this point, the drone has been restored to its factory settings, and the drone is ready for flight.

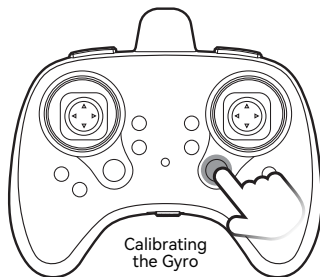

FLIGHT CONTROL

Throttle Up

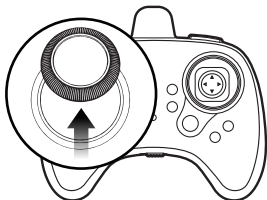

Climb

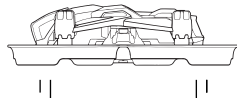

Throttle Down

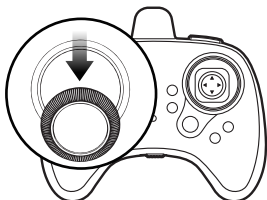

Descend

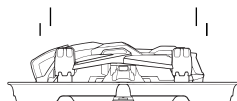

Rudder Left

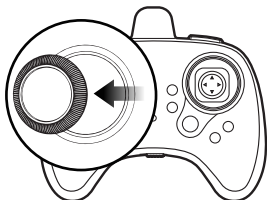

Yaw Left

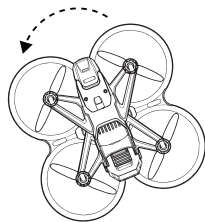

Rudder Right

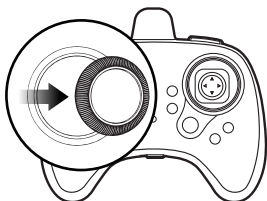

Yaw Right

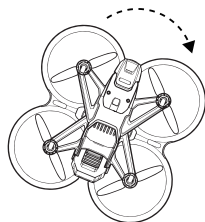

Elevator Up

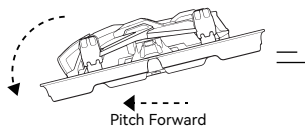
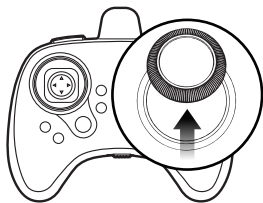

Pitch Forward

Elevator Down

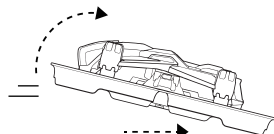
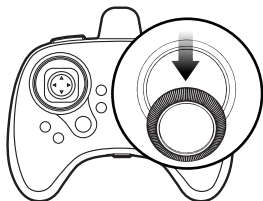

Pitch Backward

Aileron Left

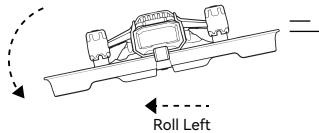
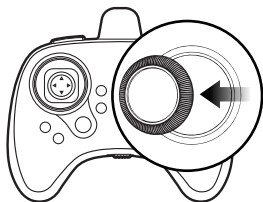

Roll Left

Aileron Right

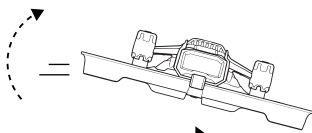
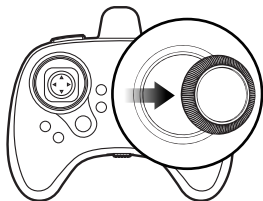

Roll Right

START FLYING

Method 1:

Press the takeoff button briefly once, and the drone will automatically take off to a height of 1.2 meters.

Press the button again briefly, and the drone will automatically land.

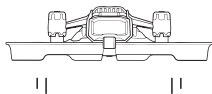

One-key takeoff

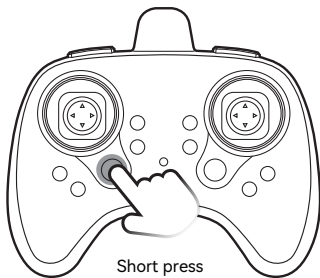

Short press
One-key takeoff/landing

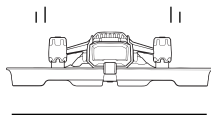

One-key landing

Method 2:

Push the left joystick all the way down, and the drone will descend slowly.

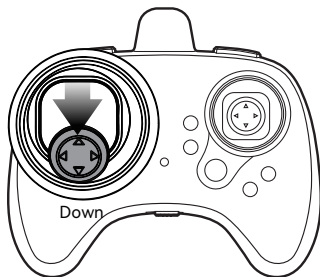

HOVER (IMPORTANT)

- The aircraft can adjust the throttle automatically to maintain a relatively stable altitude in altitude assist mode. There is no need to over control the throttle.
- The aircraft can adjust the throttle automatically to maintain a relatively stable altitude in altitude assist mode. However, it is still necessary to manually control the horizontal movement of the aircraft to maintain stable flight.
- When practicing to hover above the same position, please apply frequent micro adjustments to the right joystick to counter the omnidirectional drift that the aircraft might encounter. (For more details, please download HISINGY App to perform aircraft trim)
- If the aircraft drifts towards a fixed or random direction at relatively high speed on its own, please land first before trying to identify the problem.

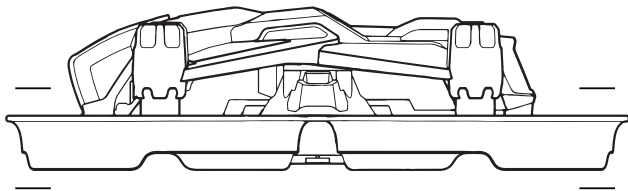

Hovering



NOTICE

If this is your first time operating an aircraft, it is recommended to ask experienced pilot for help before your first flight.

Please remember to make smooth and accurate control input to the controller joysticks.

The average flight time of the aircraft is about 4mins.

LAND

- To land the aircraft, first maintain a low altitude (60cm) hover, then lower the throttle to the bottom until the aircraft lands and motors stop.
- In state of emergency, the aircraft can also be landed by long pressing the engine start button, this will trigger an emergency cutoff, which will immediately lock all propellers and cause the aircraft to free fall to the ground.
- After landing, please remove the flight battery.

Landing ↓

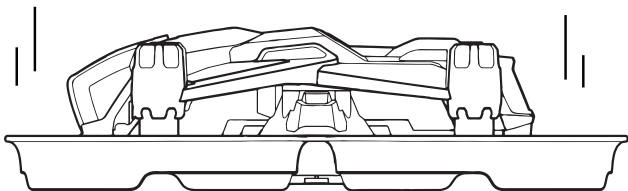

NOTICE

- To prevent excessive wear to the motors, please allow the motors to cool between flights.
- To prevent thermal damage from overheating, please allow the flight controller to cool between flights.
- Crash damage is not covered by HISINGY warranty.

AIRCRAFT TRIM

1. Adjusting the drone's forward and backward movement

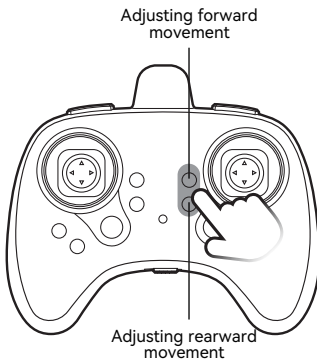
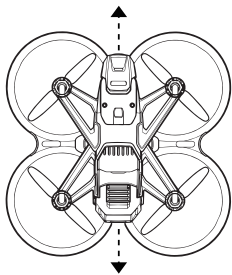

When the drone moves forward or backward during flight, you can press the rearward and forward fine-tuning buttons to make minor adjustments.

2. Adjusting the drone's lateral movement

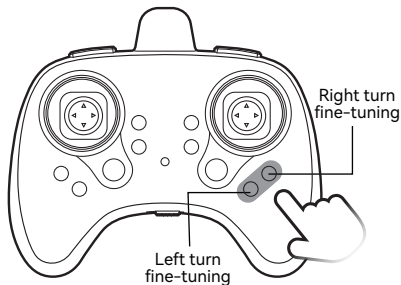
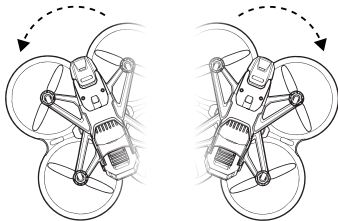

When the drone drifts to the left or right during flight, you can press the right and left fine-tuning buttons to make minor adjustments.

EMERGENCY STOP



Press and hold the emergency stop button for more than 3 seconds, and the drone's motors will cease operation.

If the drone experiences a crash and the motors continue to run or the drone becomes uncontrollable, you can press and hold the emergency stop button to shut down the drone.

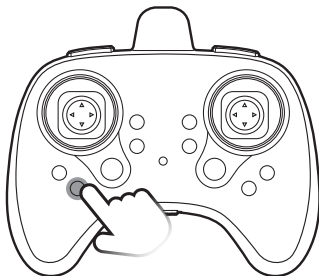

Press and hold for 3 seconds
Emergency stop

SPEED ADJUSTMENT

Press the speed button on the remote control briefly, and the drone can switch to three different speed modes: slow, fast, and ultra-fast.

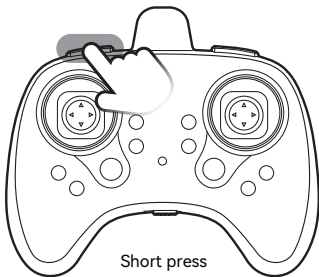

Short press
Three gear levels

HEADLESS

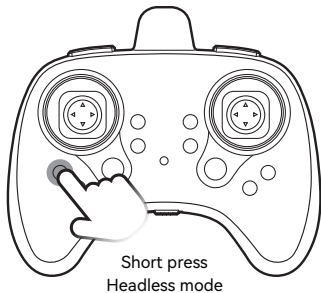

Press the Headless Mode button on the remote control briefly, and it will make a beep sound. At the same time, the LED lights on the drone's body will flash twice, pause for 0.5 seconds, and then flash twice more, pausing for 0.5 seconds again. At this point, the drone has entered Headless Mode for flight.

Headless Mode is a flight control mode that allows the aircraft to ignore the direction of its nose during flight, making control more intuitive and easier.

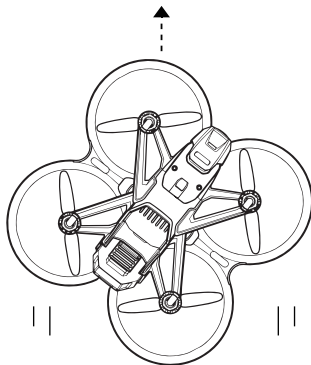

LED LIGHTS

Press the LED light button, and the LED lights on the drone's body will turn off. Similarly, press and hold the LED light button to turn them on.

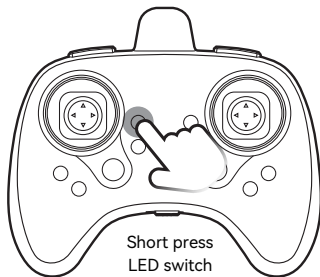

FLIP

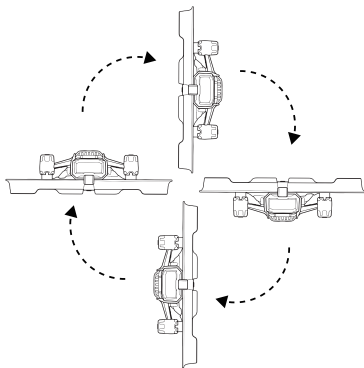
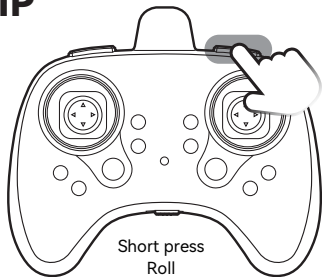

When the aircraft reaches a height of about 2 meters above the ground, you can enter the flip mode by lightly pressing the 'One-key Flip' button. After entering the flip mode, the pilot can control the direction of the aircraft's roll by moving the right (directional) joystick.

CICLE FLY

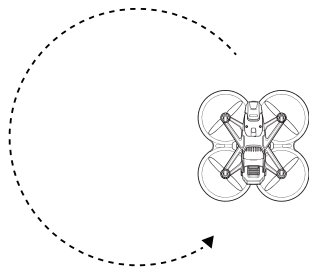
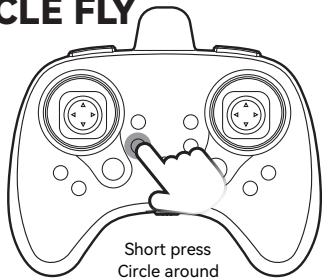

When the aircraft reaches an altitude of about 2 meters above the ground, you can enter the orbit mode by lightly pressing the 'One-key Orbit' button. After entering the orbit mode, the aircraft will begin to circle counterclockwise. You can control the orbit range by moving the left joystick left and right, and you can cancel the orbit flight by moving the right joystick at any time.

DON'T PANIC WHEN ENCOUNTERING PROBLEMS

problem	cause	method of handling
remote control malfunction	excessive flying distance	Ensure the remote control distance is within 100 meters.
	strong wind	Do not fly in windy conditions, as wind can limit the drone's capabilities and interfere with your control over the flight.
The drone cannot ascend	The propeller rotation is too slow	Move the power control stick up
	The drone's battery is not fully charged	Fully charge the drone's battery
The drone plummets rapidly	Rapidly retract the power control stick	Slowly pull back on the throttle control stick to let the drone land gently
	The battery is low on power	Replace with a fully charged battery
lose control	Beyond the effective remote control range	Ensure the remote control distance is within 100 meters

DECAL

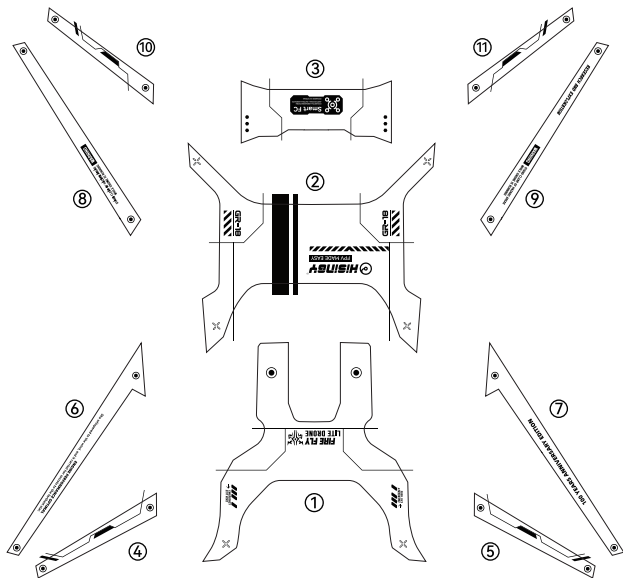

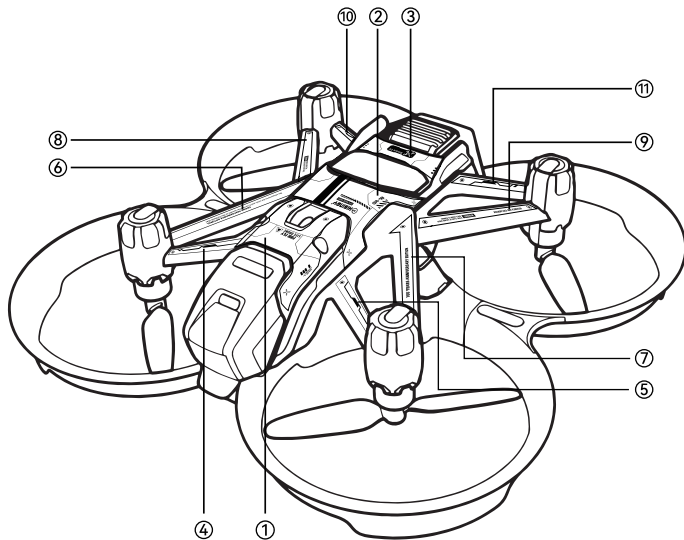

HISINGY APP

1. Download HISINGY APP



APP DOWNLOAD



2. App Item

In the App device interface (the second icon below the main menu bar), click the 'Add Equipment' button, and follow the prompts to scan the device's QR code ID to add the aircraft.

The App contains all the information related to the Star World aircraft, and you can view the electronic manual at any time.

The FIREFLY model does not support Bluetooth for adjusting the aircraft or recording flight time to earn achievements. For more advanced features, please purchase aircraft products with the 'Bluetooth' logo.

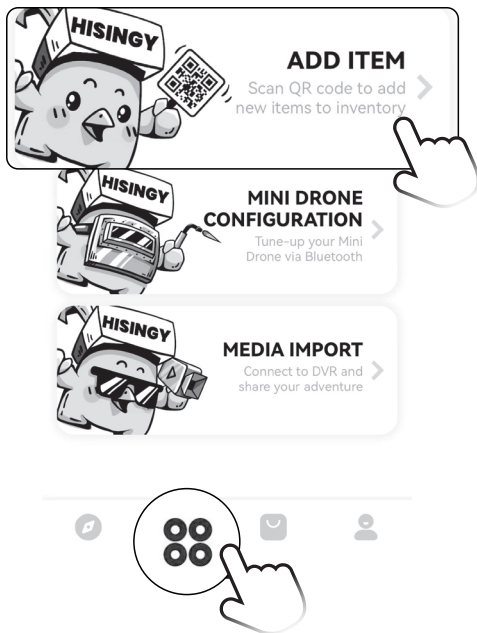

DISCLAIMER

This product is an indoor educational drone. Please train and fly it safely indoors. It is suitable for users aged 8 and above. Users should carefully read this statement and the safety operation guide before using this product. Company Cockatoo & Friends is not responsible for any direct or indirect personal injury or property loss caused by failure to follow this statement and the safety operation guide or by violating laws and regulations. Additionally, Company Cockatoo & Friends is not responsible for any other consequences. Once the product is used, it is considered that the user has understood, recognized, and accepted all the contents of this statement and the safety operation guide.

Please visit the official website www.hisingy.com to review the latest disclaimer and safety operation guide. Company Cockatoo & Friends will update this statement and the safety operation guide as needed. Updates will not be notified separately. The latest version on the official website shall prevail. The final interpretation right of this statement and the safety operation guide belongs to Company Cockatoo & Friends.

1. Safety Operation Guide - Flight Environment Requirements:

- Be sure to fly in a safe indoor area equipped with protective nets.
- Be sure to install the shell before flying.
- Fly in an environment of 0-40°C.
- Strictly comply with local laws and regulations during flight.
- Tie up long hair when using this product.
- Check the battery levels of the drone and remote control before each flight to ensure they are adequately charged.
- Ensure all components are intact before flying.
- Ensure the propellers and motors are undamaged, and the propellers are installed correctly and securely.
- Ensure the firmware, remote control, or APP is updated to the latest version.
- Do not approach or touch the rotating propellers and motors.
- Fly within visual range.
- Do not operate the product if you are in poor physical or mental condition.
- Do not use this product to throw or launch any dangerous items at buildings, people, or animals.

- Do not power on the drone immediately after it falls into water, as this will cause permanent damage to the drone.
- After the drone lands, turn off the drone's power first, then turn off the remote control.
- Do not touch the motor immediately after the flight to prevent burns.

2. Precautions and Warnings for the Use of Drone Components:

- Use original parts from Company Cockatoo & Friends. Using non-original parts may cause danger or loss.
- Ensure there are no foreign objects such as sand, dirt, or water inside the components.
- Ensure the batteries of all components are intact and working properly.
- Replace any deformed or damaged propellers before flying.
- Propellers are sharp; handle with care during installation to prevent cuts.
- Do not modify the physical structure of the motor.
- Ensure the propellers and motors are securely installed and can rotate freely.
- Do not block the motor ventilation holes or the ventilation holes on the drone shell.
- Once the drone firmware is upgraded, make sure to also upgrade the remote control to the latest firmware.
- After the firmware upgrade is complete, the remote control may disconnect from the drone; reconnect it at this time.
- Remove the propellers before upgrading the firmware.

3. Battery Usage Instructions and Warnings:

- Follow all warnings and instructions strictly when using flight batteries and remote control batteries to avoid property damage or personal injury.
- Charge the drone battery in a safe and well-ventilated area within the temperature range of 0-40°C. Keep away from flammable materials during charging.
- After each flight, remove the battery from the drone. Do not pull or tug on the battery wires when removing the battery.
- If the drone enters low battery warning mode, land and stop flying as soon as possible, and replace or recharge the battery.
- Do not leave the battery unattended while charging. Users must frequently monitor the battery during charging and stop charging or take other appropriate measures if any issues arise.
- After flying or discharging the battery, allow it to cool to ambient temperature or room temperature before recharging.
- If the battery swells, stop charging or discharging immediately. Safely and quickly remove the



battery, place it in an open area away from flammable materials, and observe it for at least 15 minutes. Continuing to charge or discharge a swollen battery can cause a fire. Stop using the battery even if it is only slightly swollen.

- Store the battery at room temperature in a dry environment.
- Do not store the battery in a hot garage, car, or in direct sunlight.
- During use, do not leave the battery, charger, and power supply unattended.
- Do not attempt to charge a low-voltage, swollen, damaged, or wet battery.
- Do not charge the battery if the wires are damaged or short-circuited.
- Do not discard the battery, charger, and power supply carelessly.
- Check the battery, charger, and power supply before charging.
- Ensure proper polarity connection of the battery terminals before connecting the battery, charger, and power supply.
- The positive and negative power wires of the battery should remain insulated to prevent short circuits. Maintain battery safety.
- Disconnect the power connection before charging.
- If there is any malfunction of the battery, charger, or power supply, stop all charging processes immediately.
- Do not burn the battery or throw it into fire under any circumstances, as this can cause the cells to burn.
- Do not immerse the battery in any liquid, such as freshwater, seawater, or beverages (juice, coffee, cola, etc.).
- Use only batteries, chargers, and connecting wires provided by Company Cockatoo & Friends. Use of non-original parts is prohibited.
- Do not use batteries that are leaking, swollen, have damaged packaging, or show any other signs of external damage to prevent battery fire, explosion, or product damage.
- Always remove the battery from the drone before charging.
- Do not use or charge the battery in high-temperature conditions to avoid the risk of fire or explosion.
- Do not bite or pierce the battery and charger with sharp objects.
- Do not disassemble the battery under any circumstances, as this may cause internal short circuits leading to swelling, fire, or other issues.
- Do not use batteries that have been dropped or damaged by external forces.
- Do not continue to use the battery after it has fallen into water, even after it has dried.
- Do not place the battery in a microwave oven or pressure cooker.
- Do not place the battery in flammable or easily ignitable locations.

- Keep the battery, charger, power cables, and other accessories out of reach of children. If children accidentally swallow any parts, seek medical attention immediately.
- Do not place battery cells on conductive surfaces.
- Do not intentionally or unintentionally short-circuit the battery with wires or other metal objects.
- Avoid striking, dropping, bending, or allowing sharp objects to impact the battery. Clean the work environment to avoid sharp objects and ensure you do not wear sharp jewelry while handling the battery.
- Do not place heavy objects on the battery or charger.
- Prevent the battery from coming into contact with contaminants to avoid poor contact and other damage.
- Do not charge the battery immediately after a flight; allow it to cool to room temperature first.
- Do not charge the battery unattended. Disconnect the charger from the battery once charging is complete. Regularly inspect the charger and battery for external damage.
- Do not charge the battery with a damaged or poorly connected charger.
- Do not use alcohol or other flammable agents to clean the charger or battery.
- Do not overcharge or over-discharge the battery, as this can shorten the battery's lifespan.
- Do not place the battery near heat sources, such as direct sunlight, a hot car interior, fire, or a heating stove.
- Ensure the battery is used within an ambient temperature range of 0 to 40 degrees Celsius.
- If the battery is not used for an extended period (more than three months), it may enter an over-discharged state due to its self-discharge characteristics. To prevent over-discharge, periodically charge the battery. Over-discharge can result in the loss of battery function and performance.
- Do not store the battery in a fully charged state for long periods. If the battery is fully charged, ensure to fly the drone for an additional 3 minutes before storage.
- Do not transport the battery with metal objects, such as hairpins or metal necklaces, to avoid causing the battery to catch fire or explode.
- Do not transport batteries that are leaking, swollen, damaged, or show any other signs of external damage.
- If the drone crashes during flight, turn off the power and remove the battery. Carefully inspect the battery for signs of collision or impact, such as dented edges, broken wires, deformed body, or swelling. If any issues are found, replace the battery immediately and store the old battery properly, preferably in a fireproof box or bag.
- Lithium polymer batteries theoretically do not contain liquid electrolytes, but if electrolyte leakage occurs and comes into contact with skin, eyes, or other body parts, rinse immediately with water and



seek medical attention. Electrolyte is toxic.

- Ensure the battery is fully discharged before placing it in the designated battery recycling bin. Batteries are hazardous chemicals, and it is strictly prohibited to dispose of them in regular trash bins. For related details, please follow local battery recycling and disposal laws and regulations.
- If the battery cannot be activated after being over-discharged, please dispose of it as waste.
- Long-term inactivity will affect the battery's performance.

AFTER-SALES SERVICE REGULATIONS

Company Cockatoo & Friends, guided by the spirit of "high quality, superior service", provides after-sales service to customers who purchase our products. From the date of sale and issuance of a valid purchase certificate, if there are non-human quality issues under normal use, confirmed by our technical staff, customers with valid certificates can enjoy the following services at Cockatoo & Friends and its authorized repair stations.

Please note: Customers will not enjoy the rights listed above if any of the following situations occur. In such cases, our company can provide paid repair services, and customers will be responsible for the corresponding material, labor, and logistics fees incurred due to the repair:

- Faults and damages caused by force majeure;
- Faults and damages caused during user transportation, loading, and unloading;
- Faults and damages caused by customers disassembling, repairing, or modifying the product without authorization;
- Damages or water ingress caused by incorrect installation, use, and operation as per the instructions;
- Damages caused by accidental impacts or drops due to improper operation;
- Damages caused by controlling under mutual interference with other wireless devices, such as base stations, Wi-Fi signal interference, etc.;
- Damages caused by improper use of battery packs or chargers;
- Damages caused by taking off beyond the safe takeoff weight;
- Failure to ship the corresponding product within 7 natural days after contacting our company to confirm after-sales service;
- Alteration or removal of identifying labels on components;
- Inability to provide valid purchase proof or documents.



YOUTUBE



INSTAGRAM



FACEBOOK



TWITTER



©2024 Cockatoo & Friends Co., Ltd
“HISINGY” of Cockatoo & Friends Co., Ltd

All other trademarks, service marks or logos are property of their respective owners.
ver.202410

V1.2.24.12